

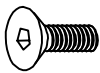

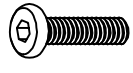

ASSEMBLY INSTRUCTION

<p>A</p>  <p>M6x16 x4</p>	<p>B</p>  <p>M6x20 x2</p>	<p>C</p>  <p>x4</p>	<p>D</p>  <p>x2</p>	<p>E</p>  <p>x1</p>	<p>F</p>  <p>x1</p>
---	---	---	---	--	---

STEP 1

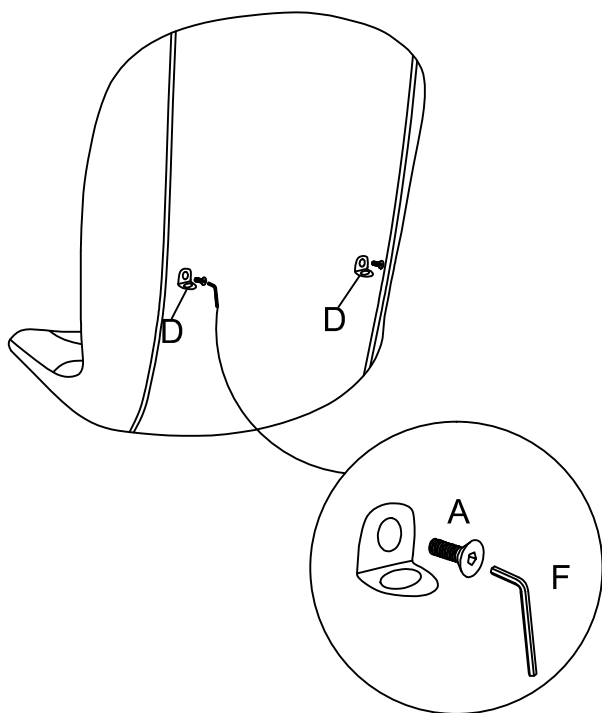

STEP 2

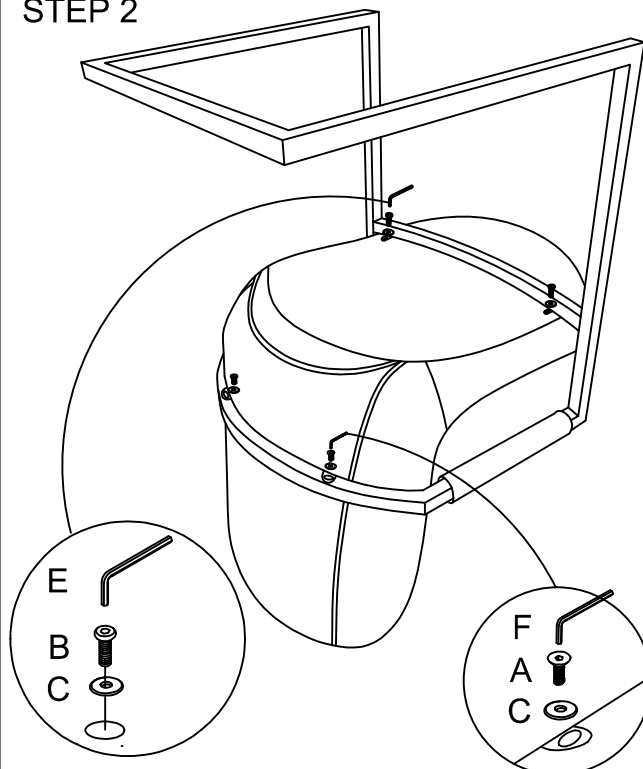

STEP 3

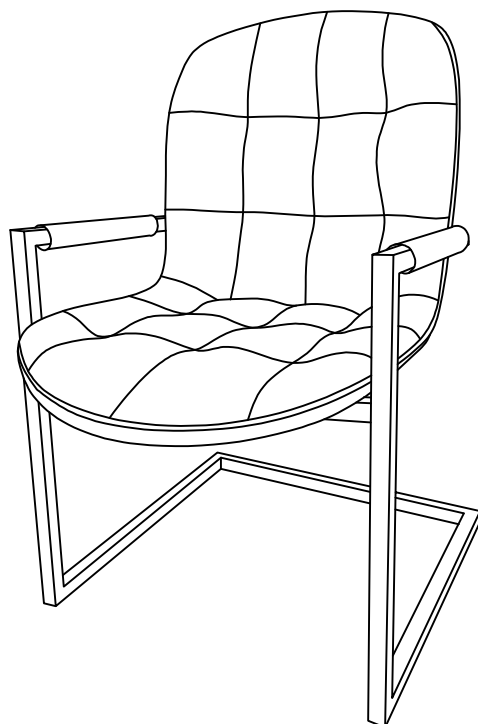

NOTE

- ① "Before you tight all screws. Please make sure all the screws in the right holes/positions."
- ② "If negative, please release the screws to adjust it to right position and tight them."