

BAR2

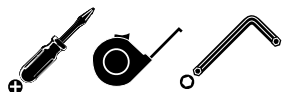

30min

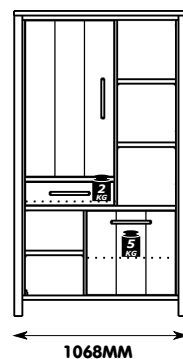
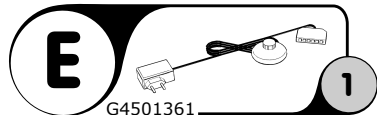
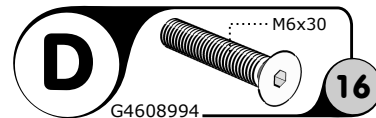
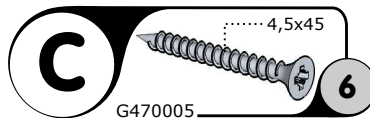
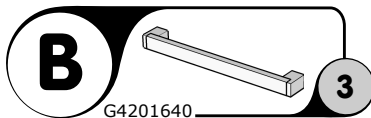
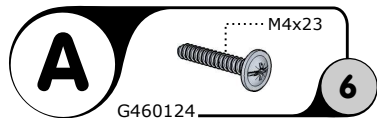

1068MM

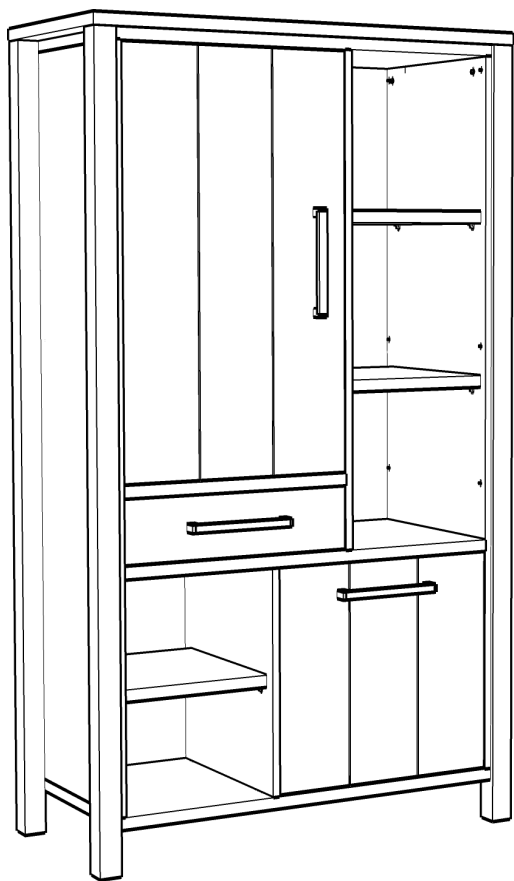

NL**ONDERHOUDSTIPS**

Oppervlakte kunststofdecor houtstructuur. Onderhoud: met lichte vochtige doek reinigen en hierna direct droog wrijven. De meubels zijn niet voor vochtige ruimten (bad, keuken etc.) bestemd. Vocht op het bovenblad direct opnemen. Montagetekening opbergen.

Het meubel moet door een vakkundig persoon, zoals in de handleiding staat beschreven worden gemonteerd. Door verkeerde montage kunnen gevaren ontstaan.

D**HINWEISE FÜR DIE PFLEGE**

Oberflächen Kunststoff-Dekor Holznachbildung. Pflegehinweis: Mit leicht feuchtem Tuch reinigen, sofort trocken nachwischen. Möbel nicht für Feuchträume geeignet (Bad, Küche etc.). Nässe auf Oberfläche unverzüglich wegwischen. Aufbauanleitung aufbewahren.

Das Möbel muss durch eine fachkundige Person entsprechend der Aufbauanleitung montiert werden. Bei fehlerhafter Montage kann es zu Gefahren kommen.

EN**ADVISE ON MAINTENANCE**

All surfaces in laminated wood colour finishes. Maintenance: clean with slightly moistened cloth, wipe dry immediately. Not suited for damp locations (kitchen, bathroom etc.). Wipe off wetness at once. Retain manual instruction.

The unit must be put together by a specialist according to the assembly instructions. Hazards may arise in case of incorrect assembly.

F**CONSEILS D' ENTRETIEN**

Panneaux de particules revêtus d'un film polymère. Entretien: utiliser un chiffon légèrement humide et repasser de suite avec un autre sec. Meuble inadapté aux pièces humides (bain, cuisine etc.). Toute trace de liquide est à essuyer immédiatement. Notice de montage à conserver.

Le meuble doit être monté par une personne spécialisée en la matière, conformément à l'instruction de montage. En cas d'erreur de montage, des dangers peuvent se manifester.

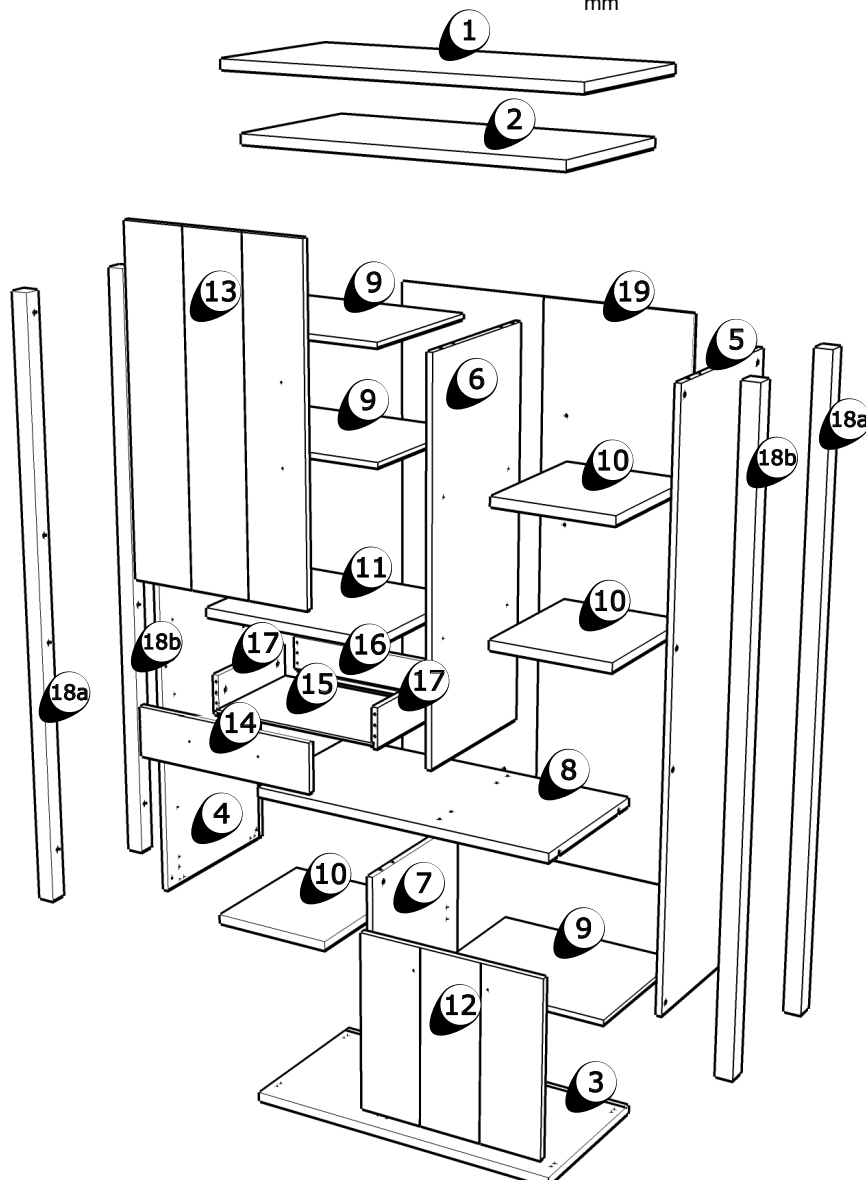
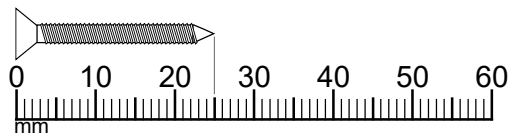
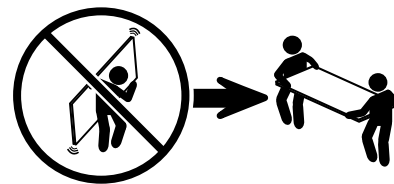
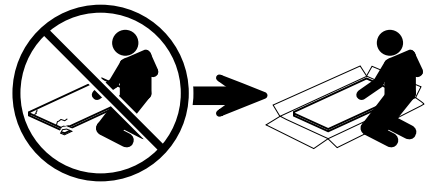

1

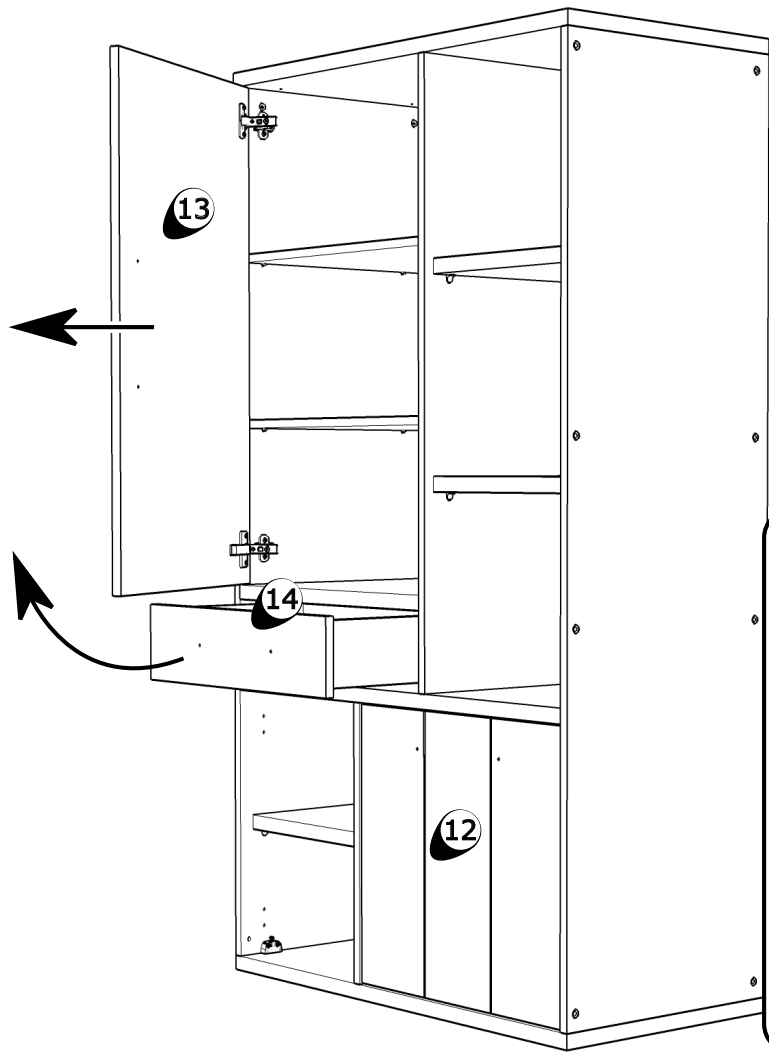

'CLICK'

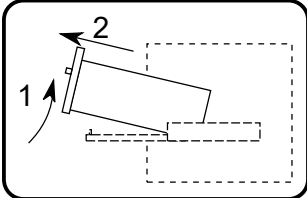
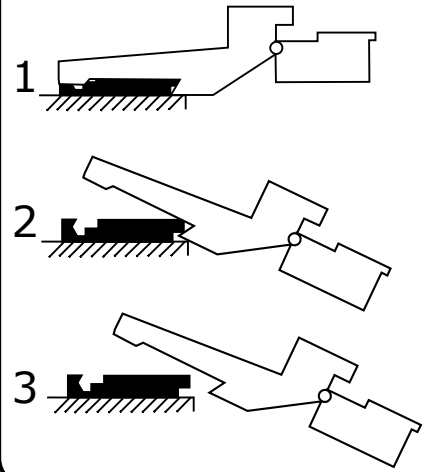

2

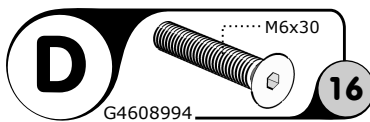
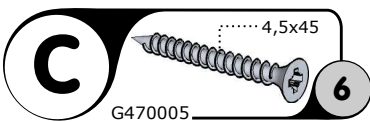
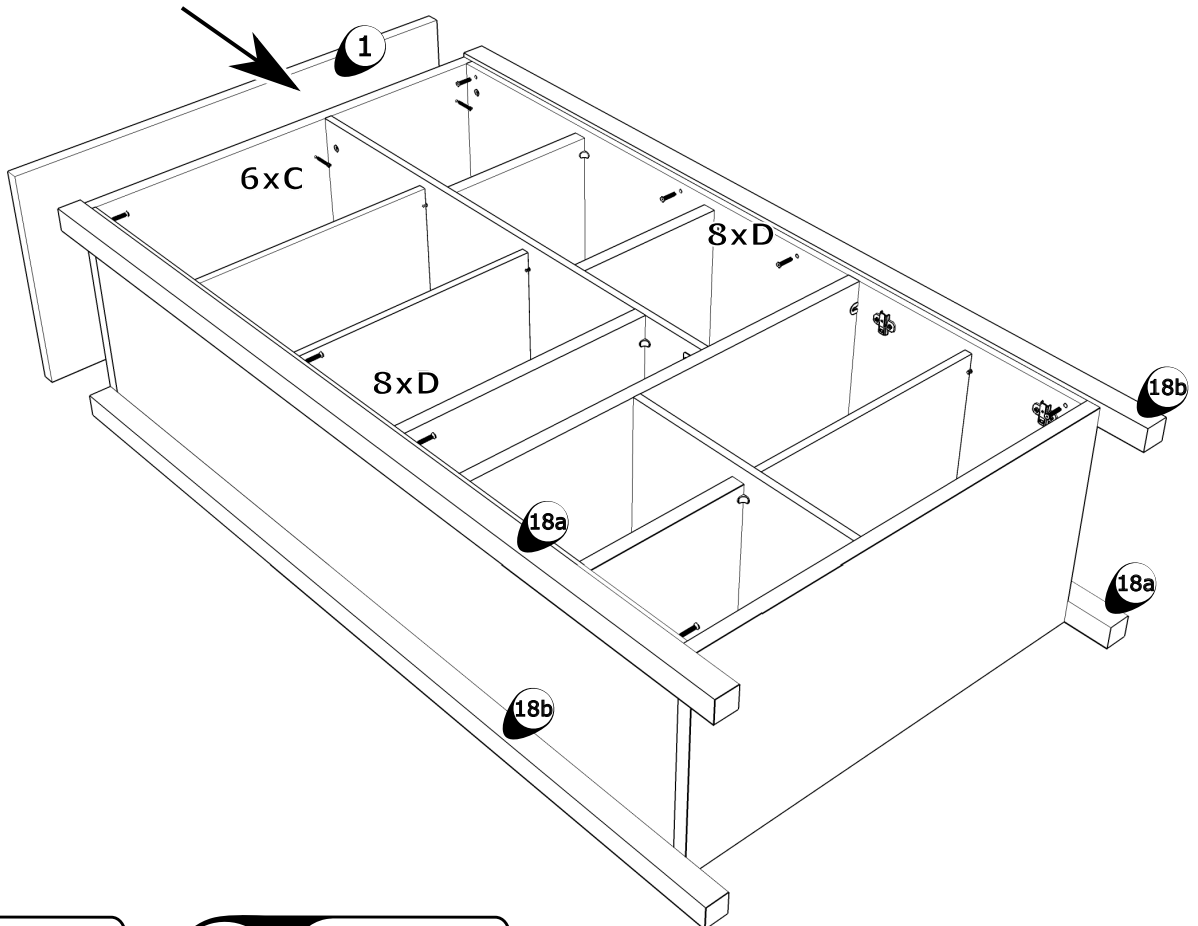

3

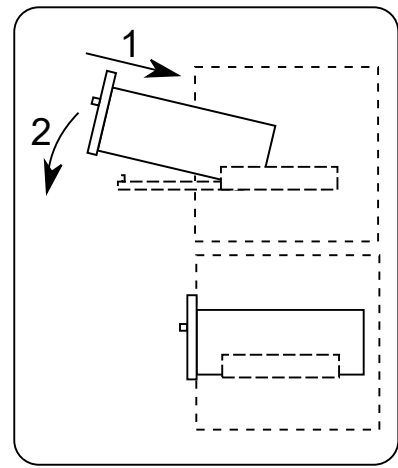
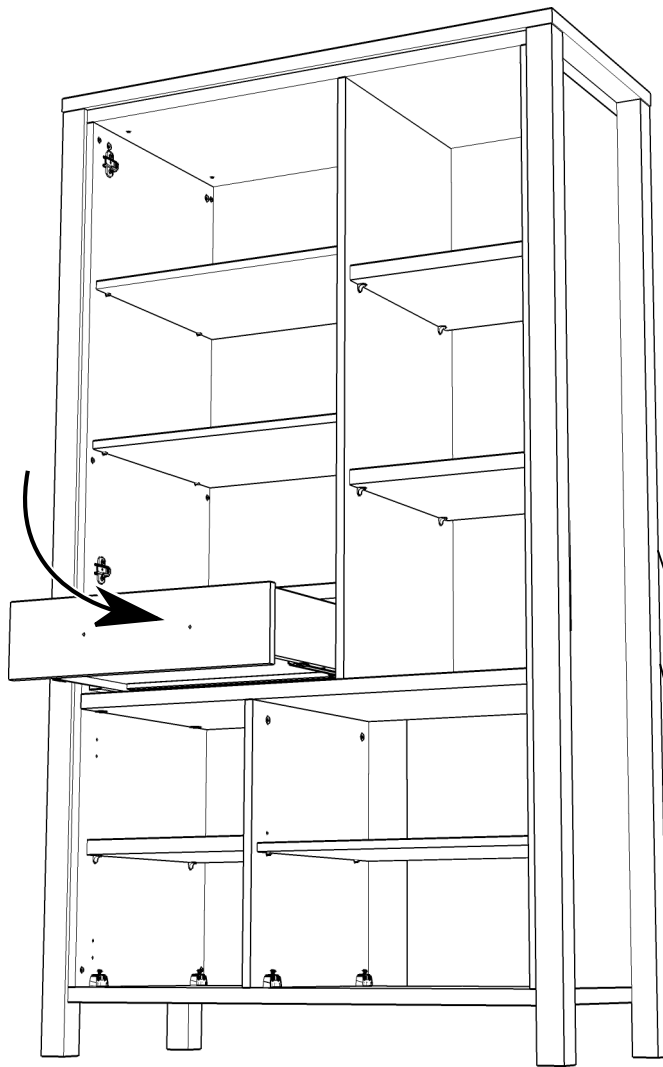

E

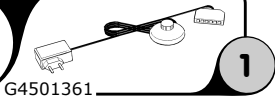

G4501361

4

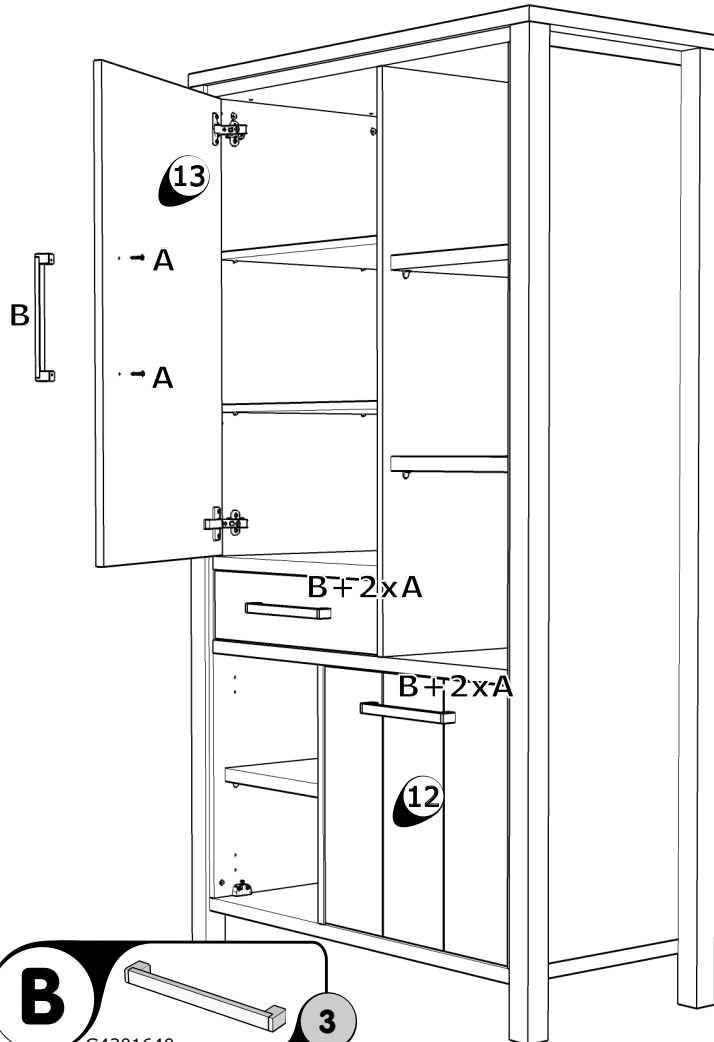

'CLICK'

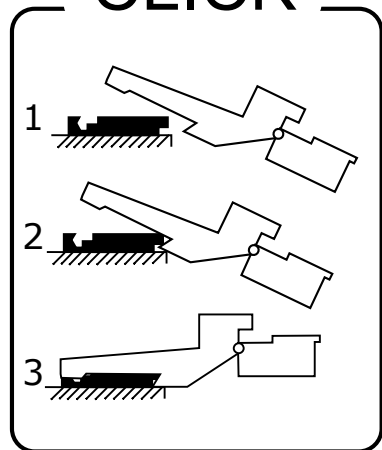

A



G460124

B

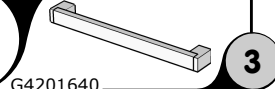

G4201640

GEGEVENS AANKOPER

INFORMATIONS ACHETEUR - BUYER INFORMATION - KAUFER INFORMATIONEN

WINKEL

MAGASIN - SHOP - GESCHÄFT

PLAATS

LIEU - TOWN - ORT

AANKOOPDATUM

DATE DE L'ACHAT - DATE OF PURCHASE - KAUFDATUM

REFERENTIE

REFERENCE - REFERENCE - REFERENZ

KLEUR

COULEUR - COLOR - FARBE

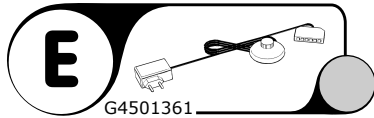
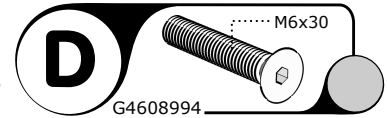
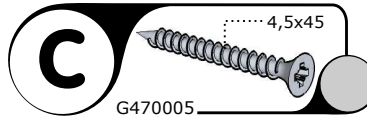
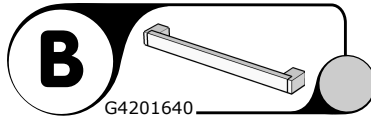
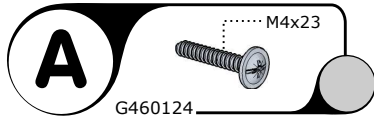
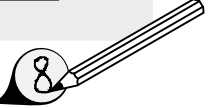

TOELICHTING EXPLICATIONS - EXPLANATION - ERKLÄRUNG

GEGEVENS AANKOPER

INFORMATIONS ACHETEUR - BUYER INFORMATION - KAUFER INFORMATIONEN

WINKEL

MAGASIN - SHOP - GESCHÄFT

PLAATS

LIEU - TOWN - ORT

AANKOOPDATUM

DATE DE L'ACHAT - DATE OF PURCHASE - KAUFDATUM

REFERENTIE

REFERENCE - REFERENCE - REFERENZ

KLEUR

COULEUR - COLOR - FARBE

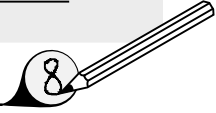

- 1** T5225273
- 2** T5225282
- 3** T5225563
- 4** T5225289
- 5** T5225290
- 6** T5225295
- 7** T5225570
- 8** T5225304
- 9** T5225297
- 10** HLOVINABANK2
- 11** T5225302
- 12** T5225314
- 13** T5225313

- 14** T5225320
- 15** T5234387
- 16** G5234375

- 17** G5234375
- 18** G4807813
- 19** G100205 L 1713 B941

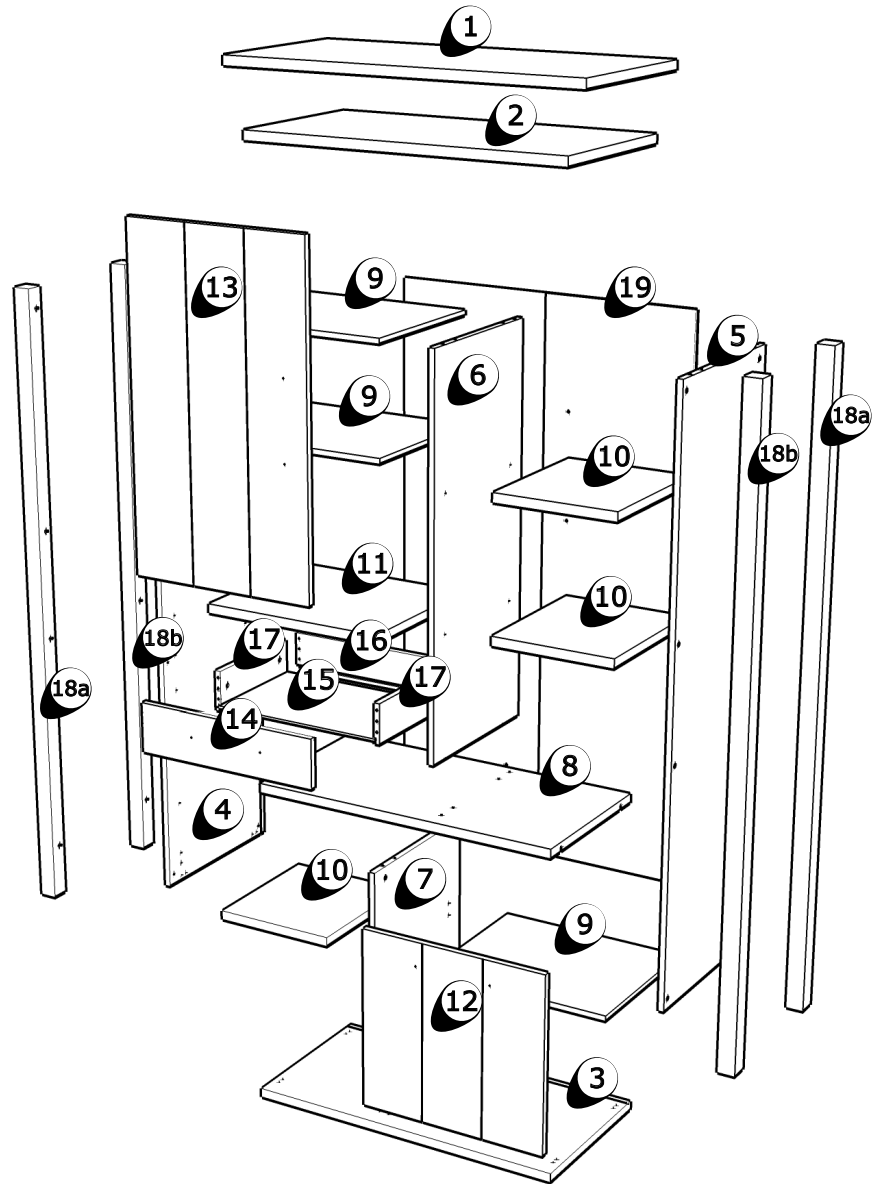

TOELICHTING EXPLICATIONS - EXPLANATION - ERKLÄRUNG